

A. ***NU2035 ERV Specifications***

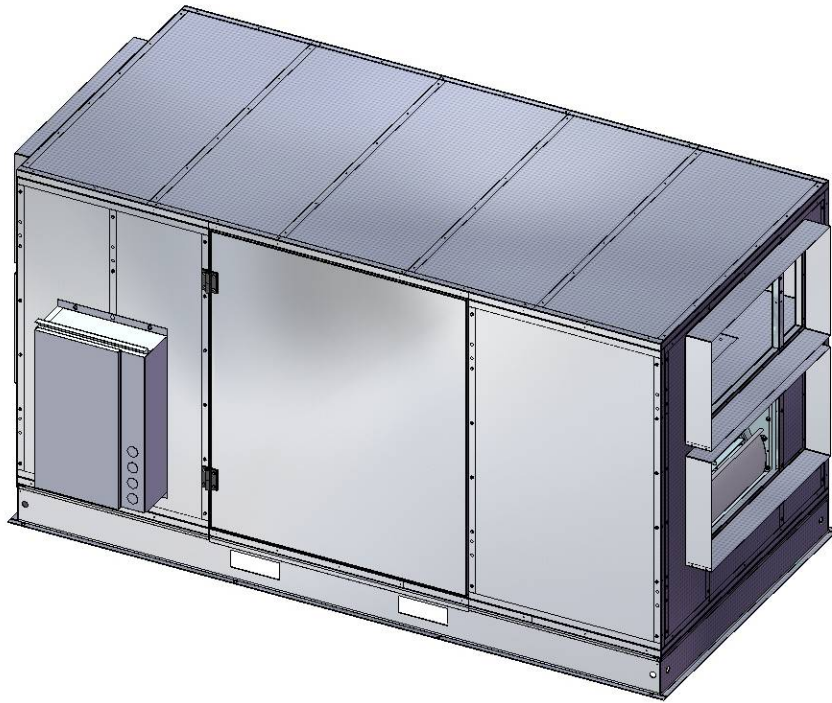

NU2035

## **B. Available Options**

### **CUSTOMIZATION:**

This series of H/ERVs is highly customizable and purpose built for the project it was designed into. See the nomenclature details that follow.

### **MOTORS:**

TEFC (Totally Enclosed Fan Cooled) ½ HP – 3 HP  
Voltage & speed options

### **CABINET:**

Double wall, 22 Ga. galvanized steel outer finish  
Optional .032 prepainted white aluminum cabinet.  
Insulation – 1” expanded polystyrene R4

### **HEAT EXCHANGER CORE:**

**HRV** - polypropylene core with sensible energy transfer  
**ERV** - enthalpy cross flow heat exchange core with the ability to *transfer both latent and sensible energy*.

### **BLOWERS:**

Belt drive performance blowers FC, DWDI

### **FILTERS:**

STANDARD - 2" pleated filters, MERV 8  
OPTIONS – MERV 13

### **WARRANTY:**

Fifteen years on Polypropylene Cores  
Five years on Enthalpy Cores  
Two years on all other components.

## **BACKDRAFT DAMPERS**



Optional gravity dampers for exhaust air and motorized intake air dampers prevent unwanted outside air from entering the space when the heat recovery unit is not operating. Factory mounted in the collar of the HRV.

## **DEFROST**

1. None - the unit may be ordered without defrost ability
2. Exhaust only defrost – a temperature sensor shuts down the supply fan when the leaving exhaust air is cold enough to freeze condensate. The supply fan remains off until the leaving exhaust air has reached +8C (47 F). The defrost sensor will allow some field adjustment of the initiation temperature.
3. Timed fan defrost – a temperature sensor shuts down the supply fan when the outside air is cold enough to freeze condensate. The supply fan remains off for a set length of time. The supply fan resumes normal operation for a set length of time and the cycle repeats as long as the outside air temperature is below the set point. Both defrost and run cycles shall be field adjustable via the unit's control.
4. Recirculation Defrost (NU0820, NU1030, NU2540) – a temperature sensor initiates defrost when outside air is cold enough to freeze condensate. The exhaust fan shuts down, the recirculation damper opens, the gravity and motorized back draft dampers close. The defrost cycle occurs for a field selectable length of time followed by a field selectable time of normal operation. The cycle repeats as long as the outside air temperature warrants.
5. Face and by Pass – a temperature sensor initiates by-pass mode when the leaving exhaust temperature is cold enough to freeze condensate. Heat recovery is interrupted and both fans continue to run. Heat recovery mode resumes when the leaving exhaust temperature is above +8C (47 F).
6. Economizer – Economizer controls are integrated with the face and by pass damper. Temperature sensors in the RA and OA communicate with an adjustable temperature sensing relay to enable free cooling when the conditions are suitable.

## **FACE AND BY ASSEMBLY**

The face and by pass assembly consists of a by pass (1), a damper (2), an actuator (3), a divider (4) and a core (5).

The damper has two opposing sections. The face which allows outside air (A) through the core for energy recovery mode and the by pass which diverts outside air around the core.

When used to defrost the HRV, a temperature sensor located in the exhaust air (D) shuts off power to the actuator when the air temperature is below freezing. Outside air (A) is diverted and delivered to the space without any preconditioning. Room air (C) is exhausted without heat recovery until the exhaust air temperature, after the core has risen 15 degrees F. This type of defrost allows for continuous, uninterrupted and balanced ventilation. This system should incorporate a reheat means for the supply air during defrost/by pass. The defrost set point is variable.

With the addition of two temperature sensors and a control relay, the face and by pass system can function as an economizer. Outside air and Room air temperatures are monitored. When conditions are suitable for free cooling, e.g. OA<72 F and RA>75 F, the actuator toggles the damper to divert the outside air to by pass mode without energy recovery. This will reduce the amount of mechanical air conditioning needed especially in evenings, overnight and in shoulder seasons. Both outside air and room air set points are variable.

Note: economizer controls do not come standard with face and by pass defrost. They must be specified at the time of ordering. If economizer controls are used, face and by pass is the only defrost option.

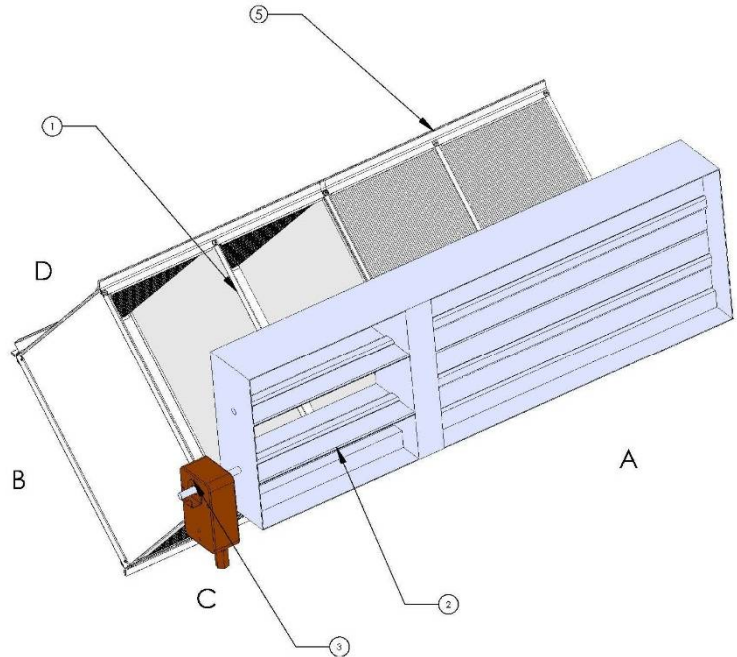

## **SPRING ISOLATORS - NU2035**

The NU2035 can be supplied with optional vibration isolators for floor mounted or suspended applications.



### **DIRTY FILTER SENSOR**

A differential pressure switch with normally open, normally closed and common terminals that toggles when differential pressure exceeds 1 in.wc. 2 per unit. Circuit can be made dry or 24 VAC with a jumper in the starter box.

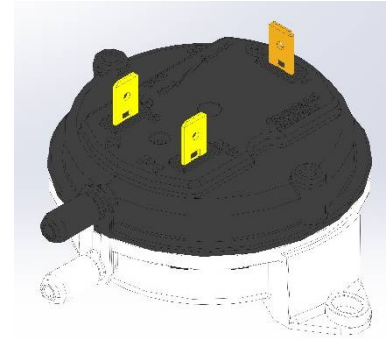

### **ROOF CURB - NU2540/NU1030**



A knock-down galvanized curb for the NU2540 comes complete with hardware and gasket material. Wooden nailing strip is field supplied and installed.

### **OUTSIDE HOODS**

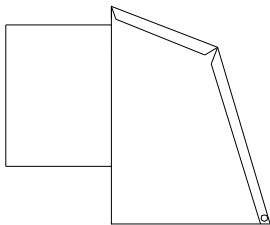

Outside Hoods are standard on the NU1030 & NU2540 but must be ordered separately with the NU2035 or NU0820

### **DISCONNECT SWITCH**

A non-fused disconnect switch, integral to the NEMA 3R starter enclosure comes **standard** with all units.

### **VFD**

An upgrade to the basic motor starters, variable frequency drives can be supplied offering a multitude of speeds and control options.

### C. Product Selection

Unit Options		NU0820	NU2035	NU1030	NU2540
Capacity (cfm range)		800 - 2000	2000 - 4000	1000 - 3000	2000 - 4000
Location	Indoor	O	S	O	O
	Outdoor	O	O	S	S
Defrost	None	S	S	S	S
	Exhaust Only (temperature on/off)	\$	\$	\$	\$
	Timed Exhaust(temperature on/timed off)	\$	\$	\$	\$
	Recirculation	\$			
	*Face and by Pass	\$	\$	\$	\$
Voltage and Speeds	240/1 1 speed	O	O	O	O
	208/3 1 speed	O	O	O	O
	460/3 1 speed	O	O	O	O
	575/3 1 speed	O	O	O	O
Core	Polypropylene	S	S	S	S
	Enthalpy	\$	\$	\$	\$
Cabinet Finish	Galvanized Steel	S	S	S	S
	Painted Aluminum (white)	\$	\$	\$	\$
Supply air Dampers	None	S	S	S	S
	Motorized	\$	\$	\$	\$
Exhaust Air Dampers	None	S	S	S	S
	Gravity	\$	\$	\$	\$
	Motorized	\$	\$	\$	\$
Supply Air discharge	Horizontal (end)	O	S	O	O
	Vertical (down)	O		S	S
Return air intake	Horizontal (end)	O	S	\$	\$
	Vertical (down)	O		S	S
VFD		\$	\$	\$	\$
Premium efficiency motors 89.5% & VFD compatible		S	S	S	S
Dirty Filter contacts		\$	\$	\$	\$
Auxiliary contacts –e.g. interlock		S	S	S	S

\* refer to motor hp tables for cfm limitations

S - standard  
 O – optional for no additional charge  
 \$ - optional for additional charge

## D. Nomenclature

NU1030, NU2035, NU2540

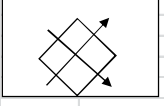
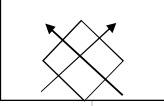
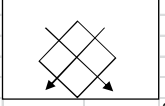
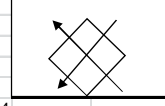
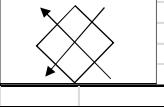
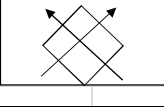
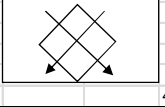
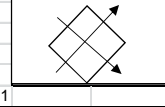
NU1030 & NU2540		Not Available in these models		NU2035		Not Available in these models	
1	4	2	4	1	3	2	3
A		B		C		D	
3	2	3	1	4	2	4	1
4	1	4	2	3	1	3	2
E		F		G		H	
2	3	1	3	2	4	1	4
1 - OA   2 - SA   3 - RA   4 - EA							





## E. *Dimensional Data*

**NU2035**

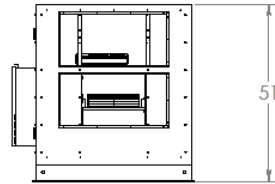
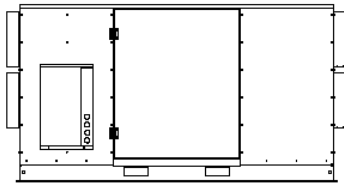
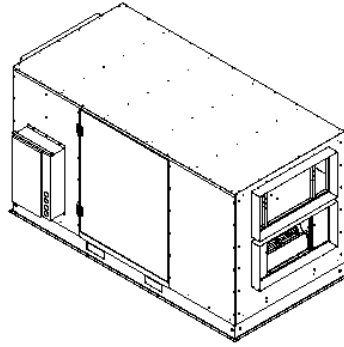
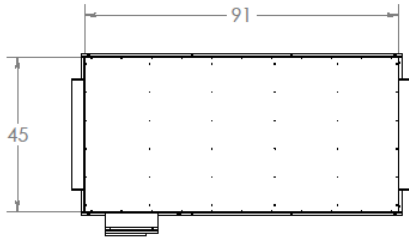

## F. Performance Data – Effectiveness

NU2035

ERV

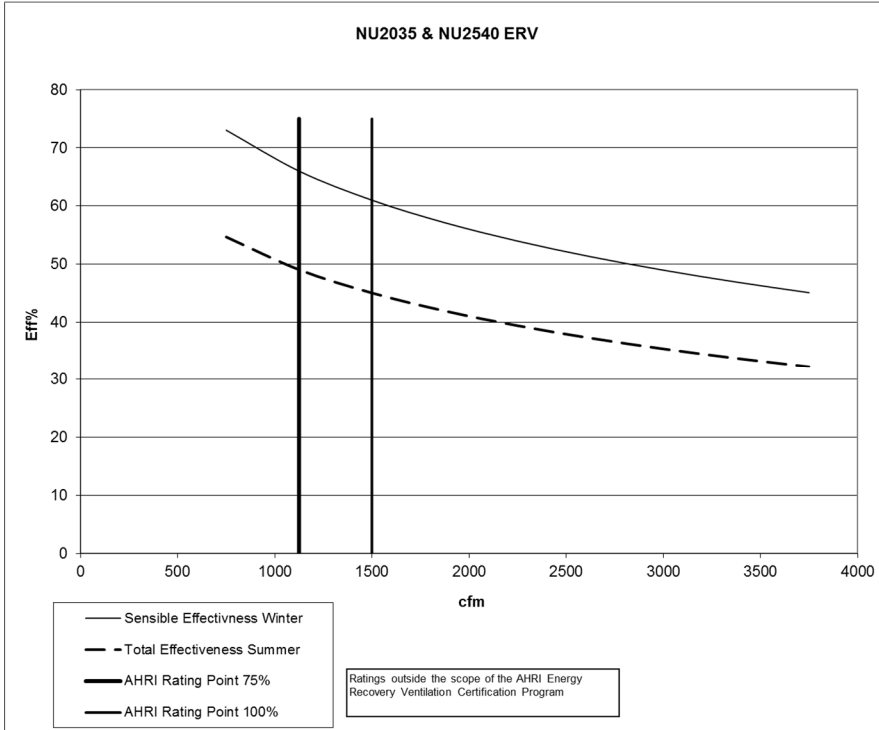

Model no.	NU2035		
Type	Plate		
Nominal Air Flow (scfm)	500		
Pressure drop (inches)	0.23		
<b>Leakage Ratings</b>			
	Diff. Pressure	EATR %	OACF
Test 1	-0.5	5	0.92
Test 2	0	0.8	1.07
Test 3	0.5	0.5	1.2
<b>Thermal Effectiveness Ratings at 0° Pressure Differential</b>			
	Sensible	Latent	Total
100% air Flow Heating	61	46	56
75% air Flow Heating	66	49	60
100% air Flow cooling	61	35	45
75% air Flow Cooling	66	39	49
	Net Sensible	Net Latent	Net Total
100% air Flow Heating	61	46	56
75% air Flow Heating	66	49	60
100% air Flow cooling	61	34	44
75% air Flow Cooling	66	39	49

# NU2035 Face and By Pass HRV

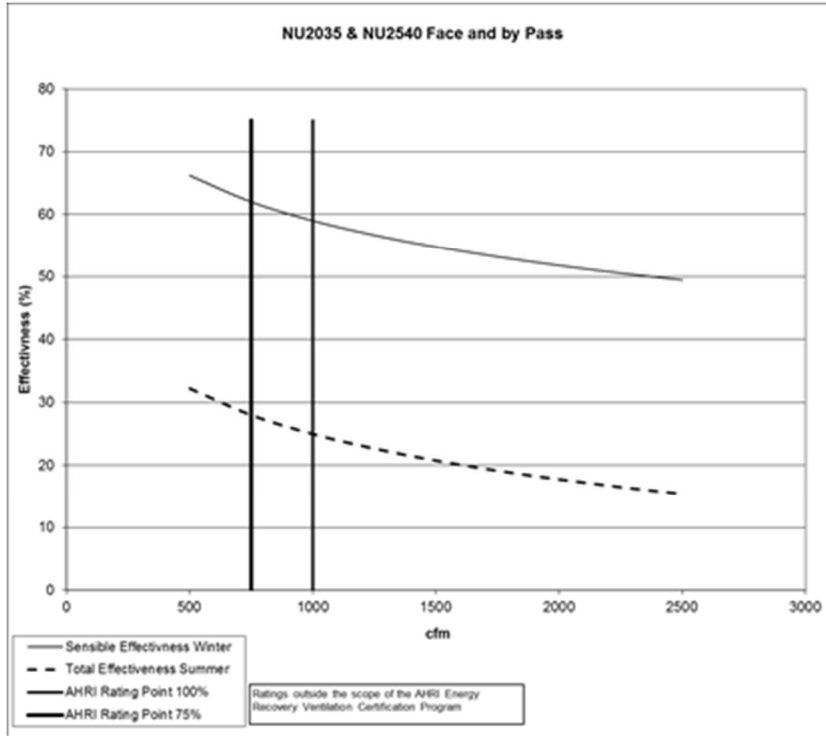

Model no.	P/C 24		
Type	Plate		
Nominal Air Flow (scfm)	500		
Pressure drop (inches)	0.18		
Leakage Ratings			
	Diff. Pressure	EATR %	OACF
Test 1	-0.5	0.00	1.00
Test 2	0	0.00	1.00
Test 3	0.5	0.00	1.00
Thermal Effectiveness Ratings at 0" Pressure Differential			
	Sensible	Latent	Total
100% air Flow Heating	59	0	38
75% air Flow Heating	62	0	42
100% air Flow cooling	60	0	25
75% air Flow Cooling	65	0	28
	Net Sensible	Net Latent	Net Total
100% air Flow Heating	59	0	38
75% air Flow Heating	62	0	42
100% air Flow cooling	60	0	25
75% air Flow Cooling	65	0	28

# ERV

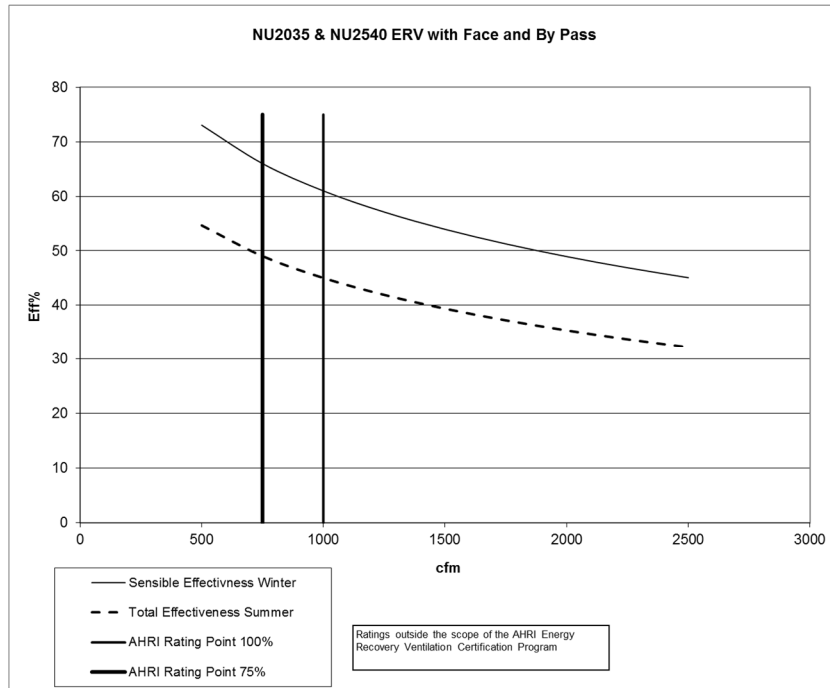

Model no.	EC-24		
Type	Plate		
Nominal Air Flow (scfm)	500		
Pressure drop (inches)	0.23		
<b>Leakage Ratings</b>			
	Diff. Pressure	EATR %	OACF
Test 1	-0.5	5	0.92
Test 2	0	0.8	1.07
Test 3	0.5	0.5	1.2
<b>Thermal Effectiveness Ratings at 0" Pressure Differential</b>			
	Sensible	Latent	Total
100% air Flow Heating	61	46	56
75% air Flow Heating	66	49	60
100% air Flow cooling	61	35	45
75% air Flow Cooling	66	39	49
	Net Sensible	Net Latent	Net Total
100% air Flow Heating	61	46	56
75% air Flow Heating	66	49	60
100% air Flow cooling	61	34	44
75% air Flow Cooling	66	39	49



## H. Performance Data – Drives

RPM Range	Pulley Set		Turns							
	Motor	Blower	5	4.5	4	3.5	3	2.5	2	1.5
5/8 motor shaft 56H										
600-800	MVL34	MBL67	600	625	650	700	725	750	775	800
750-900	MVL34	MBL57	725	750	775	800	825	875	900	925
900-1150	MVL34	MBL47	900	950	975	1000	1075	1125	1150	1175
1150-1450	MVL34	MBL37	1100	1150	1200	1250	1450			
7/8 motor shaft 145T										
1300-1500	8325x7/8	MBL37		1300	1350	1390	1425	1500		

## I. Electrical Data

### Motors – all units

Mtr Data																				
Voltage																				
hp	240/1										208/3									
	Stock	Type	Frame	RPM	Shaft	S.F.	Eff.	FLA	MCA	MOP	Stock	Type	Frame	RPM	Shaft	S.F.	Eff.	FLA	MCA	MOP
1/2	C612	TEFC	56	1725	5/8	1.15	67.1	3.6	9.1	15	H868	TEFC	56	1725	5/8	1.15	80.4	1.6	4.6	15
3/4	C669	TEFC	56	1725	5/8	1.15	69.3	5.2	12.7	20.0	H869	TEFC	56	1725	5/8	1.15	79.3	2.4	6.4	15
1	C683	TEFC	56	1725	5/8	1.15	71.0	7.5	17.9	25.0	H524	TEFC	56	1725	5/8	1.15	79.0	3.3	8.4	15
1.5	C693	TEFC	56	1725	5/8	1.15	72.0	7.5	17.9	25.0	H535	TEFC	56	1725	5/8	1.15	82.9	4.5	11.1	15.0
2	K200	TEFC	182T	1750	7/8	1.15		12.0	28.0	40.0	TE115	TEFC	145T	1730	7/8	1.15	86.5	5.6	13.6	20.0
3	K203	TEFC	184T	1725	7/8	1.15		16.0	37.0	55.0	TE121	TEFC	182T	1745	1 1/8	1.15	89.5	8.4	19.9	30.0
Voltage																				
hp	460/3										575/3									
	Stock	Type	Frame	RPM	Shaft	S.F.	Eff.	FLA	MCA	MOP	Stock	Type	Frame	RPM	Shaft	S.F.	Eff.	FLA	MCA	MOP
1/2	H868	TEFC	56C	1725	5/8	1.15	80.4	0.9	3.0	15	H276	TENV	1725	56	5/8	1.15	77.0	0.7	2.6	15
3/4	H869	TEFC	56C	1725	5/8	1.15	79.3	1.2	3.7	15	H461	TENV	1725	56	5/8	1.15	82.0	0.8	2.8	15
1	H524	TEFC	56C	1725	5/8	1.15	79.0	1.7	4.8	15	H525	TEFC	1725	56	5/8	1.15	81.0	1.4	4.2	15
1.5	H535	TEFC	56HC	1725	5/8	1.15	82.9	2.2	6.0	15	TE109	TEFC	1740	145T	7/8	1.15	86.5	1.6	4.6	15
2	TE115	TEFC	145T	1730	7/8	1.15	86.5	2.5	6.6	15	TE116	TEFC	1730	145T	7/8	1.15	86.5	2.2	6.0	15
3	TE121	TEFC	182T	1760	1 1/8	1.15	89.5	3.8	9.6	15	TE122	TEFC	1760	182T	1 1/8	1.15	89.5	3.1	8.0	15

MCA = **Minimum** circuit amps      MOP = **Maximum** over-current protection      Chose a standard sized overcurrent device equal or less than the

MCA = **Minimum** circuit amps      MOP = **Maximum** over-current protection      Chose a standard sized overcurrent device equal or less than the MOP

MCA & MOP are the HRV unit total based on both motors (supply and exhaust) being equal hp

For unequal motors: MCA = FLA(larger mtr)\*1.25 + FLA(smaller mtr) + 1      MOP = FLA(larger mtr)\*2.25 + FLA(smaller mtr) + 1 rounded down to



## **J. *Sample Specification***

### **GENERAL**

#### **System description:**

Packaged Heat (Energy) Recovery Ventilator capable of transferring sensible (sensible and latent) energy designed to be used as a standalone ventilation system or as part of an engineered HVAC system with flat plate, cross flow heat exchanger integral to the unit.

#### **Quality Assurance**

Unit shall be constructed to CSA C22.2 standards and carry the mark label of an approved certifying body. Unit shall undergo 100% functionality testing at the factory prior to shipping. Heat exchangers shall be certified and currently listed AHRI and shall meet UL 94 flame spread and smoke generation requirements.

#### **Storage and Handling**

Unit shall not be used during construction. Unit shall be stored and handled according to the manufacturer's instructions.

#### **Warranty**

Unit shall have a 2 year warranty on all parts except the core which has a 15 year warranty (polypropylene) or 5 year warranty (enthalpy).

### **EQUIPMENT**

#### **Construction**

The cabinet shall be double wall construction. 22 Ga. galvanized steel inner wall and 22 Ga. galvanized steel (0.050 painted white aluminum) outer wall. The unit shall be insulated with 1" R4 expanded polystyrene. All serviceable components shall be accessible through a hinged front access panel.

The heat exchanger core shall be easily removable for servicing.

#### **Blowers**

Blowers shall be FC DWDI, dynamically balanced and operate at not more than 1500 rpm. Internal vibration isolation is not required. Blower housing shall be galvanized steel.



## **Motors**

Motors shall be continuous duty, permanently lubricated with a service factor of 1.15, matched to the fan load and required voltage and phase. Motors enclosure shall be Totally Enclosed.

## **Electrical requirements**

The unit shall have a CSA approved industrial control panel with single point power connection, NEMA3R enclosure with integral disconnect switch and fuse protection.. The unit shall be c/w 24 VAC control transformer with 200 VA for internal and remote controls.

## **Filtration**

Unit shall come complete with 2” thick MERV 8 filters (standard).

Unit shall come complete with 2” thick MERV 13 filters (optional).

## **Heat exchanger**

Polypropylene core constructed of flame retardant material and certified and currently listed with AHRI to Standard 1060.

Enthalpy core shall be constructed of a washable polymer membrane, treated with permanent Microban® antimicrobial protection to resist mould and odour causing bacteria, have latent energy transfer properties, flame retardancy, certified and currently listed with AHRI to Standard 1060.

## **Defrost**

1. None - the unit may be ordered without defrost ability
2. Exhaust only defrost – a temperature sensor shuts down the supply fan when the leaving exhaust air is cold enough to freeze condensate. The supply fan remains off until the leaving exhaust air has reached +8C (47 F). The defrost sensor will allow some field adjustment of the initiation temperature.
3. Timed fan defrost – a temperature sensor shuts down the supply fan when the outside air is cold enough to freeze condensate. The supply fan remains off for a set length of time. The supply fan resumes normal operation for a set length of time and the cycle repeats as long as the outside air temperature is below the set point. Both defrost and run cycles shall be field adjustable via the unit’s control.
4. Recirculation Defrost (NU0820) – a temperature sensor initiates defrost when outside air is cold enough to freeze condensate. The exhaust fan shuts down, the recirculation damper opens, the gravity and motorized back draft dampers close. The defrost cycle occurs for a field selectable length of time followed by a field selectable time of normal operation. The cycle repeats as long as the outside air temperature warrants.
5. Face and by Pass – a temperature sensor initiates by pass mode when the leaving exhaust temperature is cold enough to freeze condensate. Heat recovery is interrupted and both fans

continue to run. Heat recovery mode resumes when the leaving exhaust temperature is above +8C (47 F).

6. Economizer – Economizer controls are integrated with the face and by pass damper. Temperature sensors in the RA and OA communicate with an adjustable temperature sensing relay to enable free cooling when the conditions are suitable.

### **Variable frequency drive**

No. Unit comes with motor starters.

Yes. Factory shall supply VFD for each motor.

### **Cabinet**

22 Ga. Galvanized Steel

0.050 pre-painted white aluminum

### **Dirty filter contact**

Yes – 2 pressure switches with the unit.

No – pressure switches not supplied.

### **End switch**

An auxiliary contact from each motor starter shall be provided. This contact is shipped dry but can be made 24VAC by moving a jumper.

### **Roof Curb**

A 14” roof curb shall be supplied by the equipment manufacturer.